

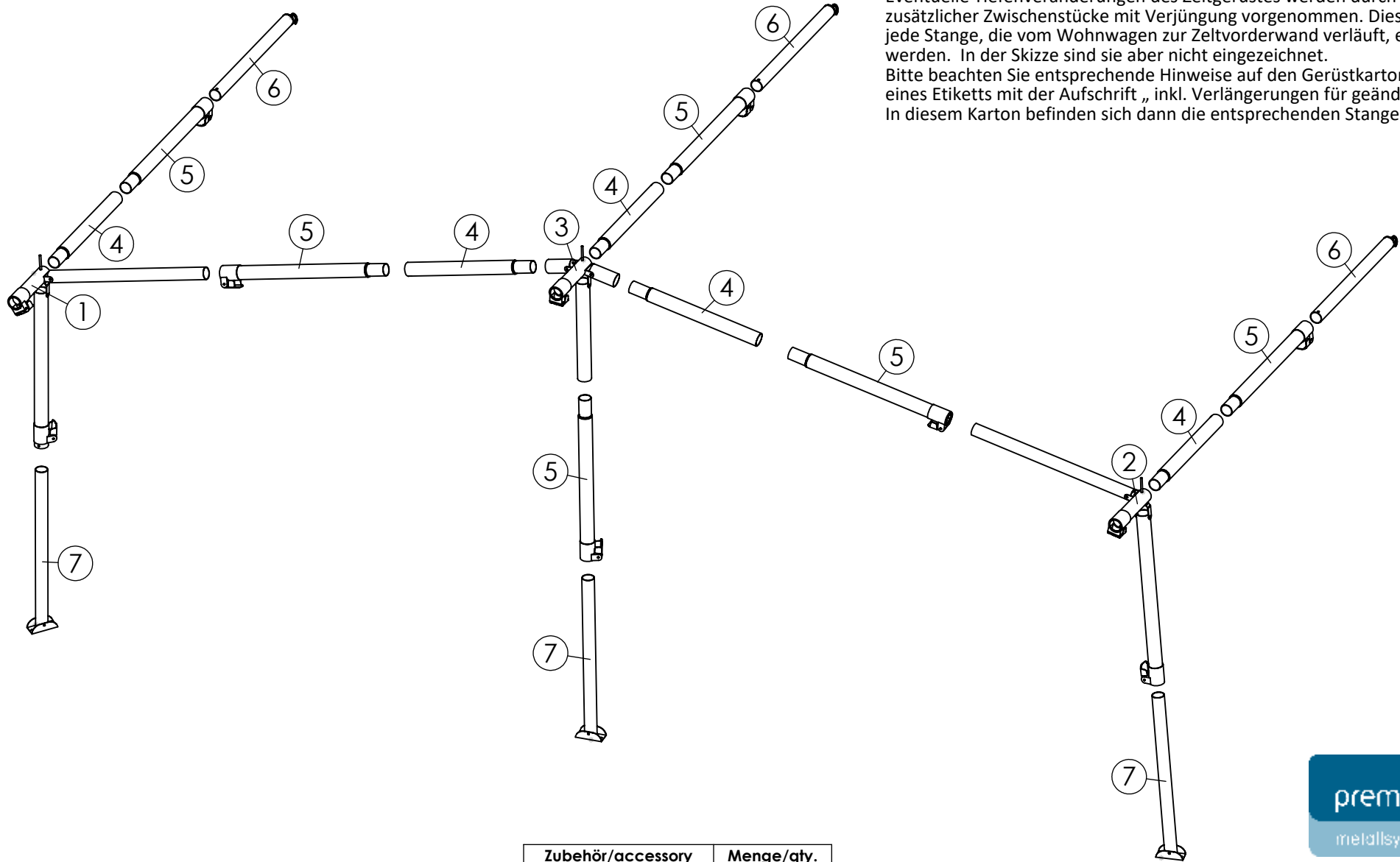





Diese Gerüstskizze bildet ausschließlich den Lieferumfang des Basismodells ab. Eventuelle Tiefenveränderungen des Zeltgerüsts werden durch Einsatz zusätzlicher Zwischenstücke mit Verjüngung vorgenommen. Diese müssen in jede Stange, die vom Wohnwagen zur Zeltvorderwand verläuft, eingebaut werden. In der Skizze sind sie aber nicht eingezeichnet. Bitte beachten Sie entsprechende Hinweise auf den Gerüstkartons in Form eines Etiketts mit der Aufschrift „inkl. Verlängerungen für geänderte Zelttiefe“. In diesem Karton befinden sich dann die entsprechenden Stangen.



Nr.	Art.-Nr.:	∅ x Länge/ ∅ x length	Menge/ qty.
1	572132500501-3	1 x 32 x 1070 mm, 1 x 28 x 910 mm	1
2	572132500502-3	1 x 32 x 1070 mm, 1 x 28 x 910 mm	1
3	572132500503-4	2 x 32 x 120 mm, 1 x 32 x 630 mm	1
4	572132086020-1	32 x 860 mm	5
5	572132107020-1	32 x 1070 mm	6
6	572128107012-2	28 x 1070 mm	3
7	572128107012-1	28 x 1070 mm	3

Zubehör/accessory	Menge/qty.
	3
	6
 ∅ 32/28 mm	11
 ∅ 32 mm	3

Zubehör/accessory	Menge/qty.
	1



## CC 32 Grundgerüst

Stahl 32 x 1,5/ 28 x 1 mm



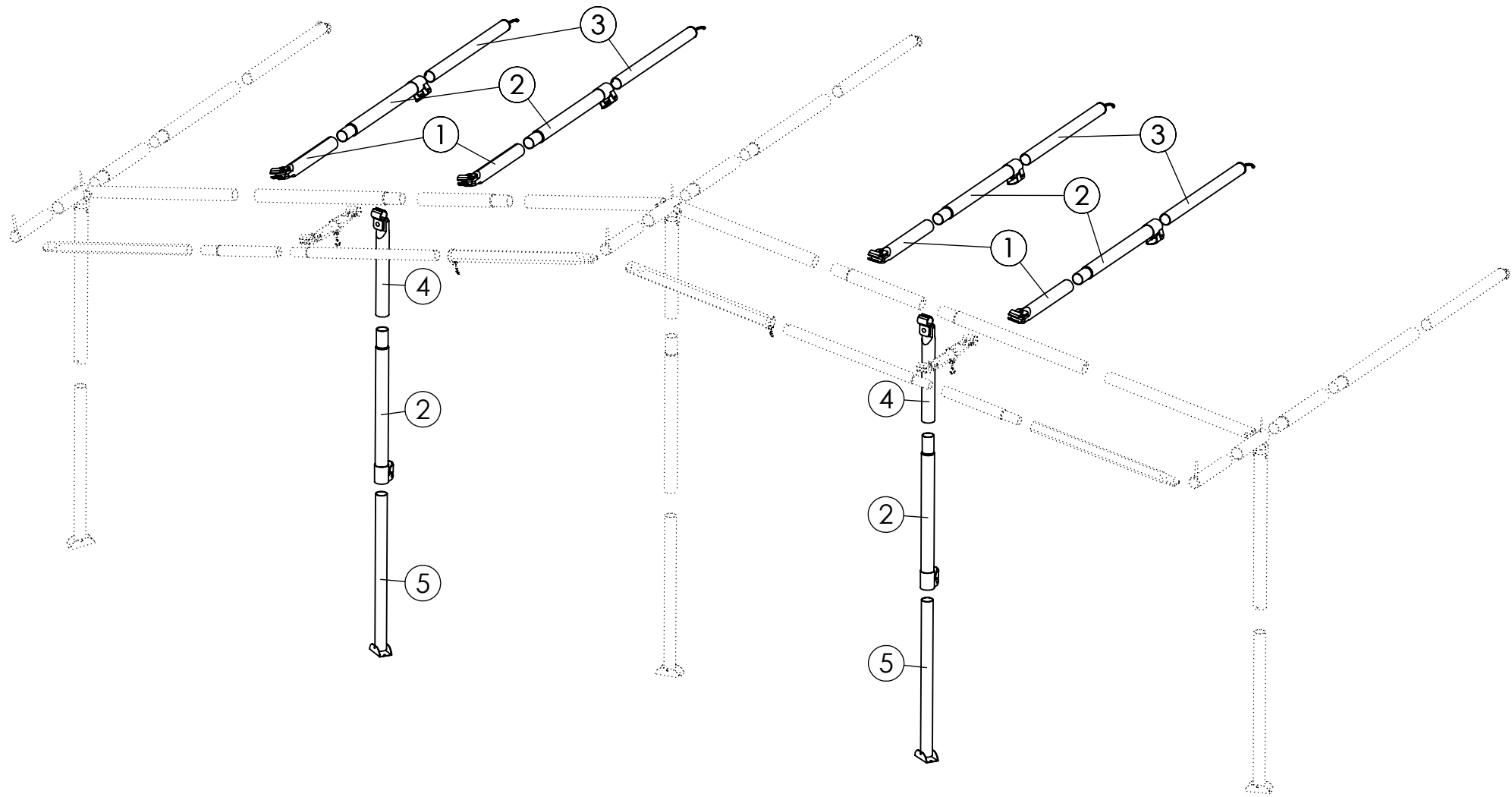

Güsto 2000

Art.-Nr.: 570432113501

SIGNATURE: 12.03.24, Schw.



Nr.	Art.-Nr.:	∅ x Länge, ∅ x length	Menge/qty.
1	572132080024	32 x 800 mm	4
2	572132107020-1	32 x 1070 mm	6
3	572128107012-2	28 x 1070 mm	4
4	572132064024	32 x 640 mm	2
5	572128107012-1	28 x 1070 mm	2

Zubehör/accessory	Menge/qty.
	4
	8
 ∅ 32/28 mm	6
 ∅ 32 mm	6



# CC Erg.-Satz Gr. 05-17

Stahl 32 x 1,5 / 28 x 1 mm

Güsto 2001

Art.-Nr: 570432500500

SIGNATURE: 12.03.24, Schw.

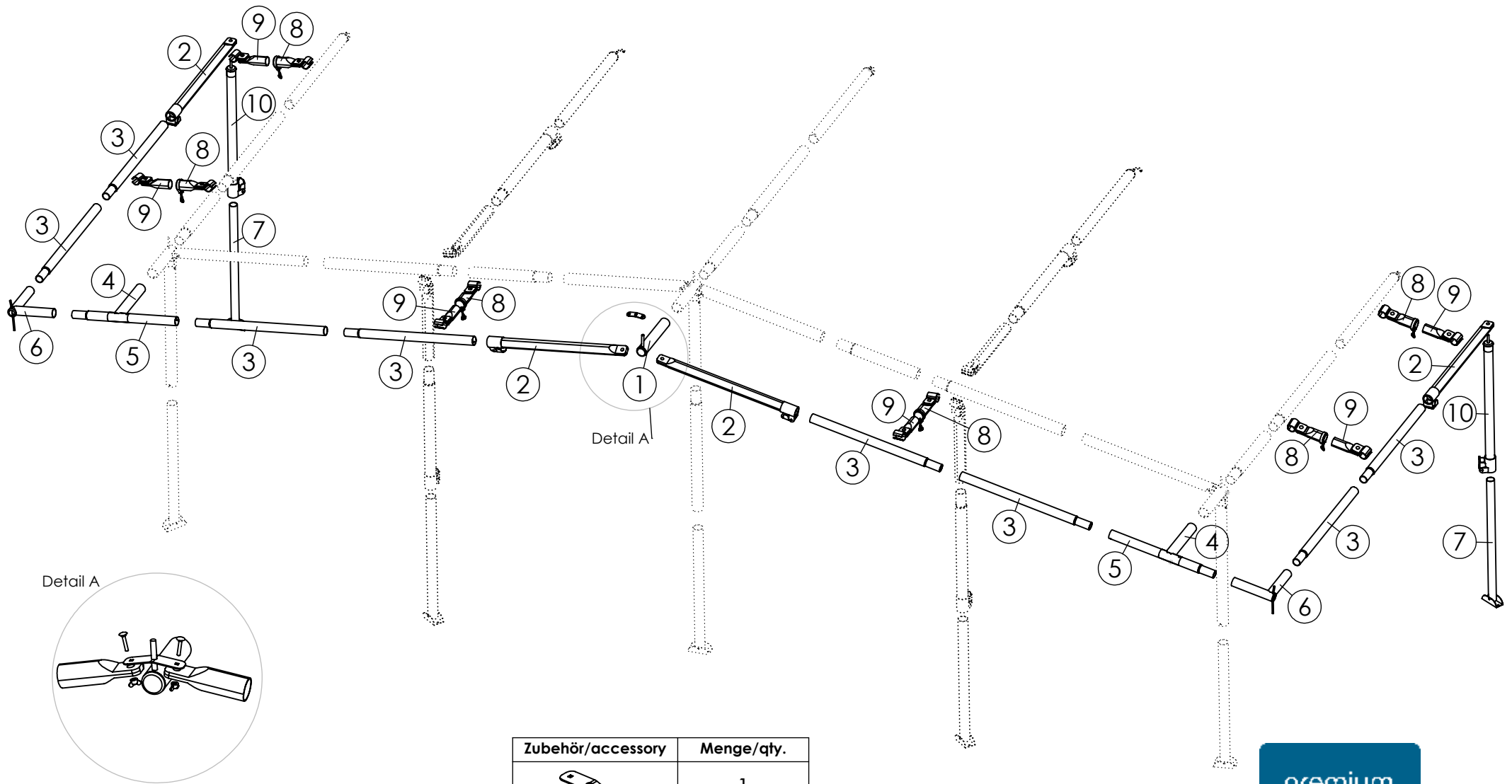

Detail A

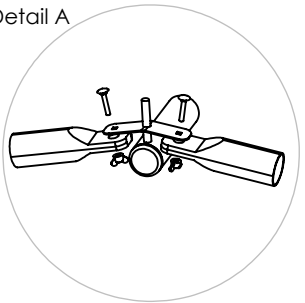

Nr.	Art.-Nr.:	∅ x Länge, ∅ x length	Menge/qty.
1	572128020032	28 x 200 mm	1
2	572128107026	28 x 1070 mm	4
3	572125107020-1	25 x 1070 mm	8
4	572128600040	28 x 200 mm, 28 x 60 mm	2
5	572125056020-1	25 x 560 mm	2
6	572125504011	2 x 25 x 200 mm	2
7	572125107012-BF	25 x 1070 mm	2
8	572122016026	22 x 160 mm	6
9	572119016024	19 x 160 mm	6
10	572128107010-2	28 x 1070 mm	2

Zubehör/accessory	Menge/qty.
	1
	2
∅ 32 mm	6
∅ 25/28 mm	6
∅ 22 mm	6
∅ 28/25 mm	6



## CC Erg.-Satz Top

Stahl 28 x 1/ 25 x 1 mm



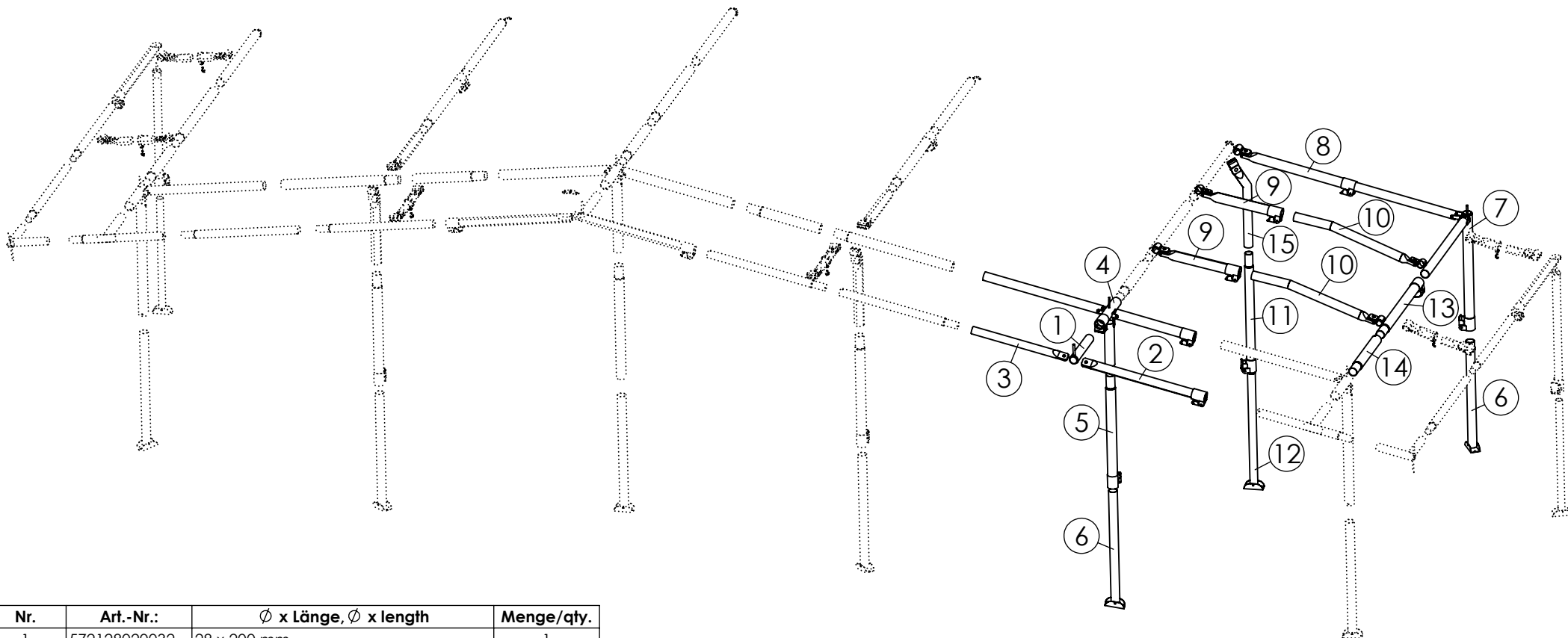

Güsto 2003

Art.-Nr.: 570432500002

SIGNATURE: 06.09.24, Schw.



Nr.	Art.-Nr.:	∅ x Länge, ∅ x length	Menge/qty.
1	572128020032	28 x 200 mm	1
2	572128107026	28 x 1070 mm	1
3	572125107026	25 x 1070 mm	1
4	572132500503-2	2 x 32 x 630 mm, 1 x 28 x 1070 mm	1
5	572132107020-1	32 x 1070 mm	1
6	572128107016-1	28 x 1070 mm	2
7	572132502001	1 x 32 x 1040 mm, 2 x 28 x 1070 mm	1
8	572132107026	32 x 1070 mm	1
9	572128064024	28 x 640 mm	2
10	572125107024-2	25 x 1070 mm gebogen	2
11	572125107020-1	25 x 1070 mm	1
12	572122107012-1	22 x 1070 mm	1
13	572132107020-1	32 x 1070 mm	1
14	572132086020-1	32 x 860 mm	1
15	572125064003	25 x 640 mm	1

Zubehör/accessory	Menge/qty.
 ∅ 25/28 mm	4
 ∅ 32 mm	4
 ∅ 32/28 mm	6
 ∅ 28/25 mm	3
 ∅ 25/22 mm	1



**Art.: Güsto 2005**

**Stahl 32 x 1,5/ 28 x 1/ 25 x 1 mm**

**Art.-Nr.: 570432500003**

Signature: 17.09.24, Schw.