

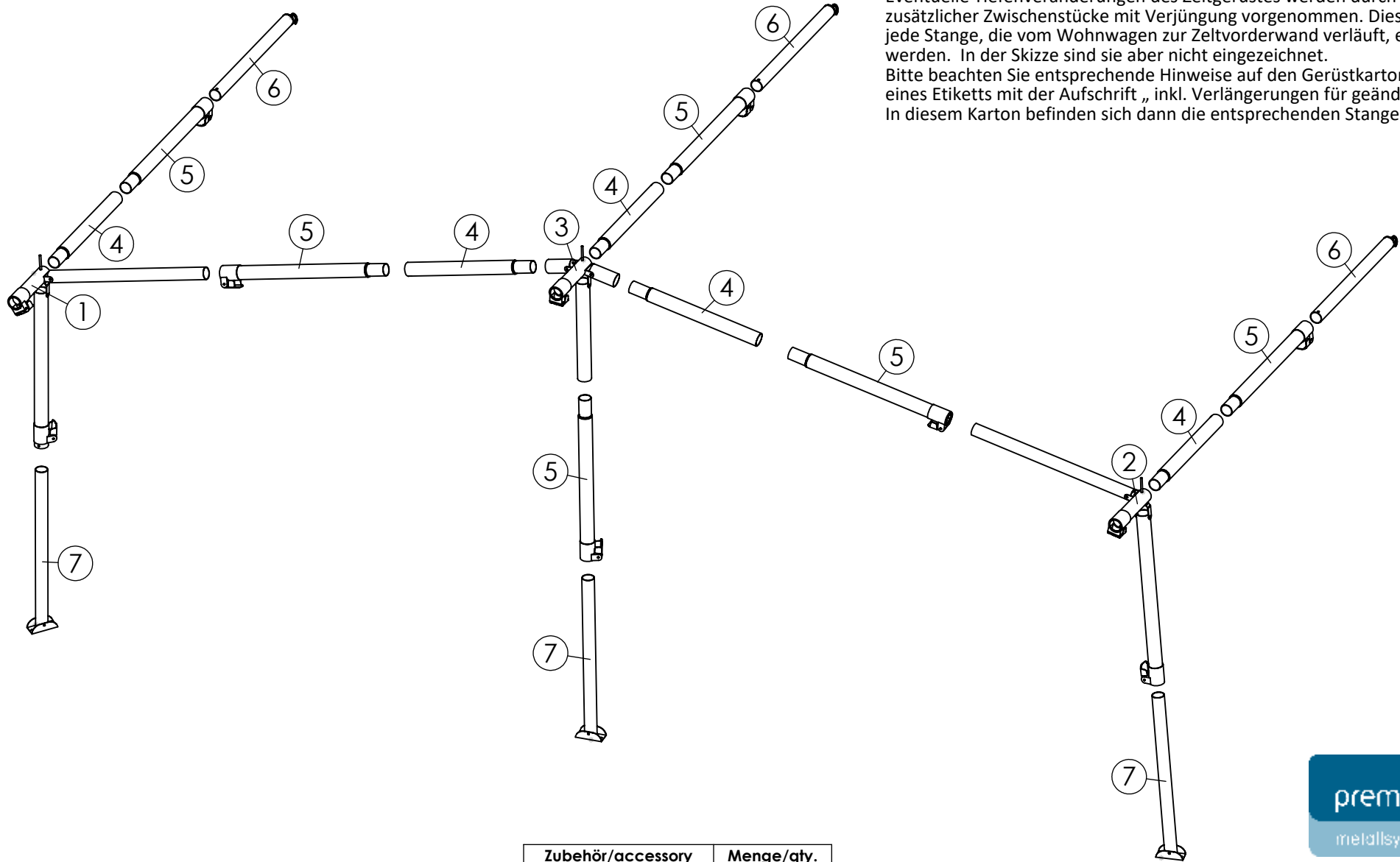





Diese Gerüstskizze bildet ausschließlich den Lieferumfang des Basismodells ab. Eventuelle Tiefenveränderungen des Zeltgerüsts werden durch Einsatz zusätzlicher Zwischenstücke mit Verjüngung vorgenommen. Diese müssen in jede Stange, die vom Wohnwagen zur Zeltvorderwand verläuft, eingebaut werden. In der Skizze sind sie aber nicht eingezeichnet. Bitte beachten Sie entsprechende Hinweise auf den Gerüstkartons in Form eines Etiketts mit der Aufschrift „inkl. Verlängerungen für geänderte Zelttiefe“. In diesem Karton befinden sich dann die entsprechenden Stangen.



| Nr. | Art.-Nr.: | ∅ x Länge/ ∅ x length | Menge/ qty. |
|-----|----------------|-----------------------------------|-------------|
| 1 | 572132500501-3 | 1 x 32 x 1070 mm, 1 x 28 x 910 mm | 1 |
| 2 | 572132500502-3 | 1 x 32 x 1070 mm, 1 x 28 x 910 mm | 1 |
| 3 | 572132500503-4 | 2 x 32 x 120 mm, 1 x 32 x 630 mm | 1 |
| 4 | 572132086020-1 | 32 x 860 mm | 5 |
| 5 | 572132107020-1 | 32 x 1070 mm | 6 |
| 6 | 572128107012-2 | 28 x 1070 mm | 3 |
| 7 | 572128107012-1 | 28 x 1070 mm | 3 |

| Zubehör/accessory | Menge/qty. |
|--|------------|
|  | 3 |
|  | 6 |
|  ∅ 32/28 mm | 11 |
|  ∅ 32 mm | 3 |

| Zubehör/accessory | Menge/qty. |
|---|------------|
|  | 1 |



CC 32 Grundgerüst

Stahl 32 x 1,5/ 28 x 1 mm

Güsto 2000

Art.-Nr.: 570432113501

SIGNATURE: 12.03.24, Schw.

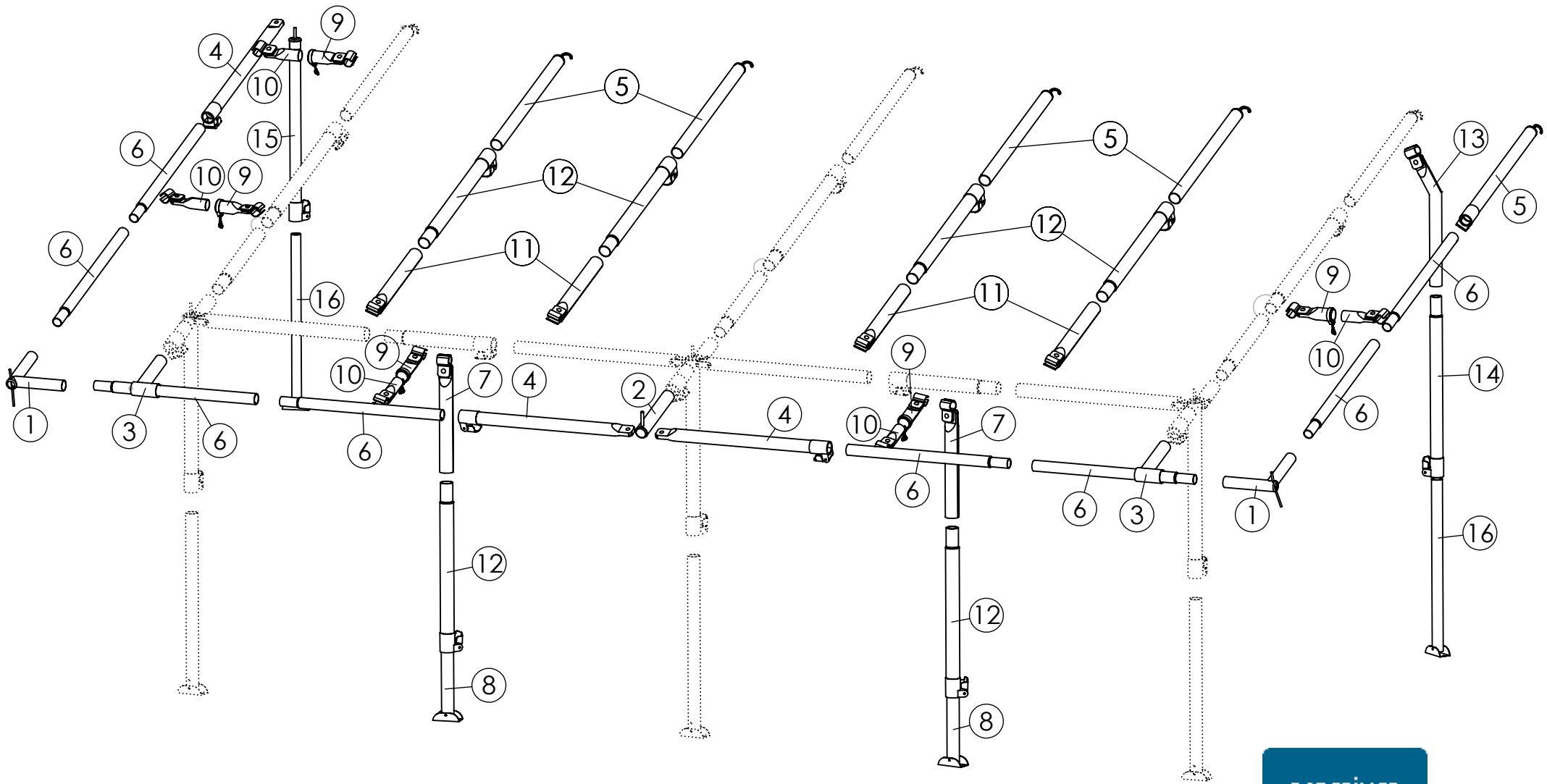

CC-Erg.-Satz Links/rechts





Stahl 32 x 1,5/ 28 x 1/ 25 x 1 mm





Güsto 2008

Art.-Nr.: 570432500005

SIGNATURE: 05.12.24, Schw.

| Nr. | Art.-Nr.: | Ø x Länge/ Ø x length | Menge/ qty. |
|-----|----------------|------------------------------|-------------|
| 1 | 57212550411 | 2 x 25 x 200 m,m | 2 |
| 2 | 572128020032 | 28 x 200 mm | 1 |
| 3 | 572128600040 | 1 x 28 x 200, 1 x 28 x 60 mm | 2 |
| 4 | 572128107026 | 28 x 1070 mm | 3 |
| 5 | 572128107012-2 | 28 x 1070 mm m. HK | 5 |
| 6 | 572125107020-1 | 25 x 1070 mm | 8 |
| 7 | 572132064024 | 32 x 640 mm | 2 |
| 8 | 572128107012-1 | 28 x 1070 mm m. BF | 2 |
| 9 | 572122016026 | 22 x 160 mm | 5 |
| 10 | 572119016024 | 19 x 160 mm | 5 |
| 11 | 572132080024 | 32 x 800 mm | 4 |
| 12 | 572132107020-1 | 32 x 1070 mm | 6 |
| 13 | 572128064030 | 28 x 640 mm geb. | 1 |
| 14 | 572128107020-1 | 28 x 1070 mm | 1 |
| 15 | 572128107010 | 28 x 1070 mm | 1 |
| 16 | 572125107012-1 | 25 x 1070 mm m. BF | 2 |

| Zubehör/accessory | Menge/quantity |
|---|----------------|
|  | 5 |
|  | 10 |
|  Ø 32/28 | 6 |
|  Ø 28/25 | 6 |
|  Ø 22 mm | 5 |

| Zubehör/accessory | Menge/quantity |
|---|----------------|
|  Ø 32 mm | 11 |
|  Ø 25/28 mm | 6 |
|  | 1 |
|   | 2 |